



Grillo

AGRIGARDEN MACHINES



G Z1 - G Z2 - G Z3



G Z1



G Z2



G Z3

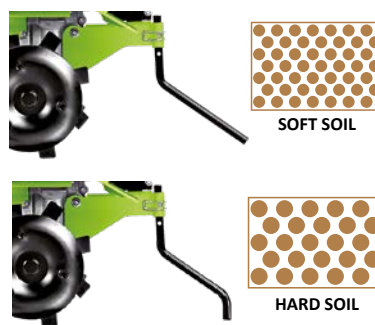

		HP-kW	 CC /	 L (US qts)						 kg (lb)
G Z1	575 EX B&S	HP 3 - kW 2.2	140/1	0,8 (0.84)		155 rpm	--	A 28 cm (11 in)	52 cm (20 in)	35 (77)
G Z2	575 EX B&S	HP 3 - kW 2.2	140/1	0,8 (0.84)		155 rpm	Max 2,1 km/h (1.3 mph)	A 28 cm (11 in)	52 cm (20 in)	41 (90)
G Z3	GCV 170 Honda	HP 4.8 - kW 3.6	166/1	0,9 (0.95)		155 rpm	Max 2,1 km/h (1.3 mph)	A 28 cm (11 in)	75 cm (29.5 in)	45 (99)

PRINCESS

M1 - MR





PRINCESS MR

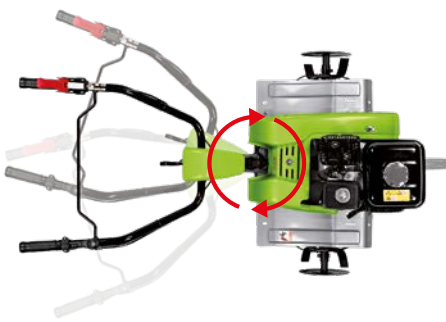

PRINCESS M1



		HP-kW	CC	 L (US qts)						 kg (lb)
M1	G 200 FA Loncin	HP 5.5 - kW 4.1	196/1	3 (3.2)		① 132 rpm	--	A 32 cm (12 in)	30-52-77 cm (12-20-30 in)	62 (137)
MR	G 200 FA Loncin	HP 5.5 - kW 4.1	196/1	3 (3.2)		① 132 rpm	Max 2,3 km/h (1.4 mph)	A 32 cm (12 in)	30-52-77 cm (12-20-30 in)	64 (141)
	GX 200 Honda	HP 5.5 - kW 4.1	196/1	3,1 (3.3)						62 (137)

PRINCESS

MP3 - MP3 PRO



PRINCESS MP3



PRINCESS MP3 PRO

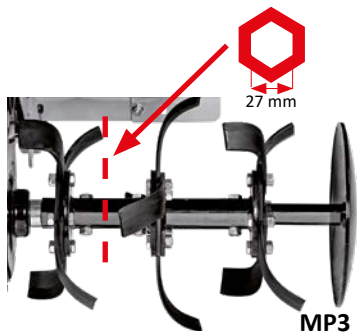

MP3 PRO



MP3



MP3 LABOUR KIT

		HP-kW	CC	 L (US qts)						 kg (lb)
MP3	G 200 FA Loncin	HP 5.5 - kW 4.1	196/1	3 (3.2)		ⓘ 36 rpm Ⓜ 160 rpm	Max 2,3 km/h (1.4 mph)	A 32 cm (12 in)	30-52-77 cm (12-20-30 in)	65 (143)
MP3 PRO	G 200 FA Loncin	HP 5.5 - kW 4.1	196/1	3 (3.2)		ⓘ 36 rpm Ⓜ 160 rpm	Max 2,3 km/h (1.4 mph)	A 33 cm (13 in)	56-82 cm (22-32 in)	68 (150)
	GX 200 Honda	HP 5.5 - kW 4.1	196/1	3,1 (3.3)		ⓘ 36 rpm Ⓜ 160 rpm	Max 2,3 km/h (1.4 mph)	A 33 cm (13 in)	56-82 cm (22-32 in)	66 (145)

HR7 PRO



HR78 PRO



HR78 PRO



HR76 PRO



HR75 PRO



		HP-kW	CC/ 	 L (US qts)						 kg (lb)
HR75 PRO	G 200 FA Loncin	HP 5.5 - kW 4.1	196/1	 3 (3.2)		① 53 rpm ② 123 rpm ③ 162 rpm	Max 3 km/h (1.8 mph)	A 32 cm (12 in)	58-85-111 cm (23-33-43 in)	83 (183)
HR76 PRO	G 300 FA Loncin	HP 9.3 - kW 6.8	302/1	 6,1 (5.6)						95 (209.4)
HR77 PRO	SH178 FA Norwik	HP 5.3 - kW 4	306/1	Diesel 3,5 (3.6)						97 (213.8)
HR78 PRO	SH178 FA Norwik	HP 5.3 - kW 4	306/1	Diesel 3,5 (3.6)						105 (231.4)

11500

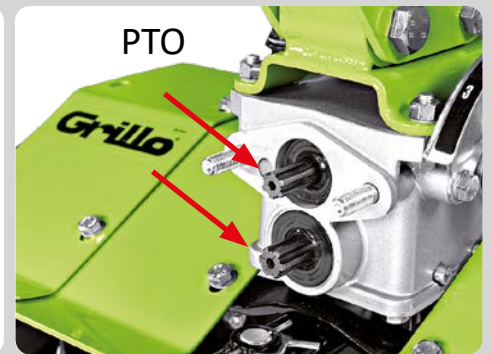
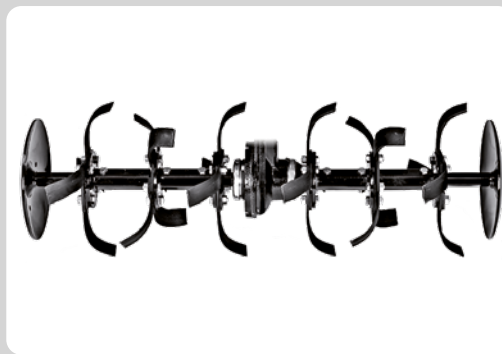
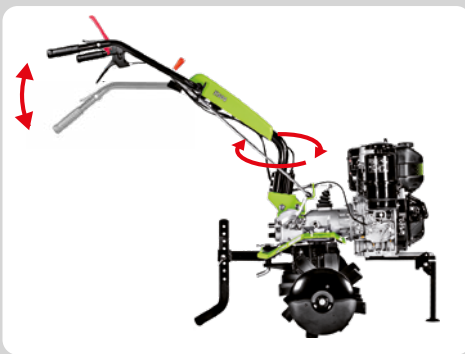









		HP-kW	CC/	 L (US qts)						 kg (lb)
11500	GX 200 Honda	HP 5.5 - kW 4.1	196/1	 3,1 (3.3)						82 (180.7)
	GX 270 Honda	HP 8.4 - kW 6.3	270/1	 5,3 (5.6)		Ⓚ 53 rpm Ⓛ 123 rpm Ⓜ 162 rpm	Max 3 km/h (1.8 mph)	A 34 cm (13.4 in)	59-86-112 cm (23-34-44 in)	90 (198.4) 98 (216)
	KD15 350 Kohler	HP 7.5 - kW 5.5	349/1	Diesel 4,3 (4.5)						110 (242.5)
										121 (266.7)

G 45

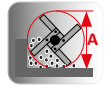
COUNTER-ROTATING TILLER





										
G 45	G 200 FA Loncin	HP 5.5 - kW 4.1	196/1	3 (3.2) L (US qts)		 4.00-8 1,6 km/h (1 mph) →	 4.00-8 2,5 km/h (1.5 mph) ←	A 26 cm (10 in)	50 cm (20 in)	82 (181) kg (lb)

G 46













COUNTER-ROTATING TILLER



										
G 46	GX 200 Honda	HP 5.5 - kW 4.1	196/1	3,1 (3.3)		 4.00-8 1,6 km/h (1 mph) →	 4.00-8 1,6 km/h (1 mph) ←	 A 26 cm (10 in)	50 cm (20 in)	98 (216)

G 52





























		HP-kW	CC	 L (US qts)						 kg (lb)
G 52	G 200 FA Loncin	HP 5.5 - kW 4.1	196/1	3 (3.2)						67 (148)
					13x5.00-6	13x5.00-6		A 26 cm (10 in)	37-50 cm (15-20 in)	
					1,4 km/h (0.9 mph)	2,2 km/h (1.4 mph)	2,2 km/h (1.4 mph)			
					→	→	←			

G 55



LABOUR KIT



		HP-kW		 L (US qts)						 kg (lb)
G 55	G 200 FA Loncin	HP 5.5 - kW 4.1	196/1	 3 (3.2)		 4.00-8	 4.00-8	 A 26 cm (10 in)	 58 cm (23 in)	89 (196)
	GX 200 Honda	HP 5.5 - kW 4.1	196/1	 3,1 (3.3)		 4.00-8  1,1 km/h (0.7 mph)  2,6 km/h (1.6 mph)  1,1 km/h (0.7 mph)  2,6 km/h (1.6 mph)	 4.00-8  1,1 km/h (0.7 mph)  2,6 km/h (1.6 mph)  1,1 km/h (0.7 mph)  2,6 km/h (1.6 mph)			87 (192)

G 84



FORWARD AND COUNTER-ROTATING TILLER

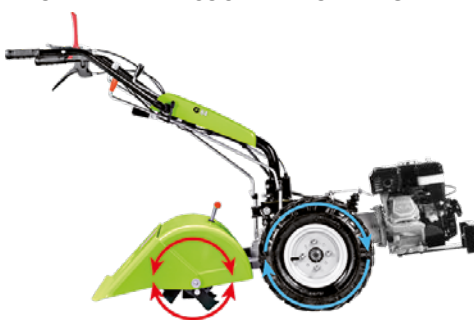

















		HP-kW	CC	 L (US qts)						 kg (lb)
G 84	GX 200 Honda	HP 5.5 - kW 4.1	196/1	3,1 (3.3)		4.00-8 1,1 km/h (0.7 mph) 2,6 km/h (1.6 mph)	4.00-8 1,1 km/h (0.7 mph) 2,6 km/h (1.6 mph)	A 32 cm (12 in)	37-47-58 cm (15-19-23 in)	111 (245)

G 85d



FORWARD AND COUNTER-ROTATING TILLER



		HP-kW	CC	 L (US qts)		 DIFF. LOCK					 kg (lb)		
G 85d	G 300 FA Loncin	HP 9.3 - kW 6.8	302/1	6,1 (6.4)		✓	 4.00-10	 4.00-10			127 (280)		
	GX 270 Honda	HP 8.4 - kW 6.3	270/1	5,3 (5.6)		✓	⓪ 1,3 km/h (0.8 mph)	⓪ 1,3 km/h (0.8 mph)			127 (280)		
	R 300 D Rato	HP 8.2 - kW 6	301/1	5,4 (5.7)		✓	Ⓜ 3,0 km/h (1.9 mph)	Ⓜ 3,0 km/h (1.9 mph)	→	→	142 (313)		
	KD15 350 Kohler	HP 7.5 - kW 5.5	349/1	Diesel 4,3 (4.5)	 	✓	⓪ 1,3 km/h (0.8 mph)	⓪ 1,3 km/h (0.8 mph)	←	←	132 (291)		
									Ⓜ 3,0 km/h (1.9 mph)	Ⓜ 3,0 km/h (1.9 mph)	←	←	151 (332)
									A 32 cm (12 in)	37-47-58-68- 77 cm (15-19-23-27- 30 in)			

G 107d



		HP-kW	CC	 L (US qts)		 DIFF. LOCK					 kg (lb)
G 107d	G 300 FA Loncin	HP 9.3 - kW 6.8	302/1	 6,1 (6.4)		✓	 5.00-10	 5.00-10			136 (300)
	GX 270 Honda	HP 8.4 - kW 6.3	270/1	 5,3 (5.6)		✓	 ① 1,3 km/h (0.8 mph) ② 2,4 km/h (1.5 mph) ③ 3,6 km/h (2.2 mph)	 ① 1,3 km/h (0.8 mph) ② 2,4 km/h (1.5 mph) ③ 3,6 km/h (2.2 mph)			136 (300)
	R 300 D Rato	HP 8.2 - kW 6	301/1	 5,4 (5.7)		✓	 ① 1,3 km/h (0.8 mph) ② 2,4 km/h (1.5 mph) ③ 3,6 km/h (2.2 mph)	 ① 1,3 km/h (0.8 mph) ② 2,4 km/h (1.5 mph) ③ 3,6 km/h (2.2 mph)	→		150 (330)
	KD15 440 Kohler	HP 11 - kW 8.1	441/1	Diesel 5 (5.3)		✓	 ① 1,3 km/h (0.8 mph) ② 2,4 km/h (1.5 mph) ③ 3,6 km/h (2.2 mph)	 ① 1,3 km/h (0.8 mph) ② 2,4 km/h (1.5 mph) ③ 3,6 km/h (2.2 mph)	←	A 32 cm (12 in)	37-47-58-68-77 cm (15-19-23-27-30 in)

G 108 - G 110



























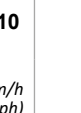









G 108

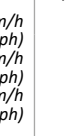

G 110



		 CC/HP HP-kW	 DIESEL L (US qts)		 Steering Brakes	 DIFF. LOCK					 kg (lb)
G 108	GX 270 Honda	270 cc/1 HP 8.4 - kW 6.3	 5,3 (5.6)				 5.00-10	 5.00-10			136 (300)
	GX 390 Honda	389 cc/1 HP 11.7 - kW 8.7	 6,1 (6.4)				 I 1,3 km/h (0.8 mph) II 2,4 km/h (1.5 mph) III 4,3 km/h (2.7 mph)	 I 1,3 km/h (0.8 mph) II 2,4 km/h (1.5 mph) III 4,3 km/h (2.7 mph)			144 (317)
G 110	KD15 440 Kohler	441 cc/1 HP 11 - kW 8.1	 Diesel 5 (5.3)				 I 0,7 km/h (0.4 mph) II 1,5 km/h (0.9 mph) III 3,2 km/h (2.0 mph)	 I 0,7 km/h (0.4 mph) II 1,5 km/h (0.9 mph) III 3,2 km/h (2.0 mph)			142 (313)
											A 32 cm (12.6 in)

G 131 - G 131 BC



G 131



G 131 BC

















G 131 BC



G 131 BC



G 131 BC

		HP-kW	CC/1	 L (US qts)		 DIFF. LOCK				 kg (lb)	
G 131	KD15 440 Kohler	HP11 - kW8.1	441 cc/1	Diesel 5 (5.3)		✓	 5.00-12 I 1,2 km/h (0.7 mph) II 2,4 km/h (1.5 mph) III 3,4 km/h (2.1 mph) IV 7.1 km/h (4.4 mph)	 5.00-12 I 1,7 km/h (1.0 mph) II 3,5 km/h (2.2 mph) →	A 32 cm (12.6 in)	55-70-85 cm (22-28-34 in)	192 (423)
G 131 BC	Vanguard 16 B&S	HP 14 (16*) kW10.3	479/2	8,5 (8.9)		✓	 5.00-12 I 1,2 km/h (0.7 mph) II 3,5 km/h (2.2 mph) ←	 5.00-12 I 1,2 km/h (0.7 mph) II 3,4 km/h (2.1 mph) ←	A 32 cm (12.6 in)	55-70-85 cm (22-28-34 in)	195 (430)

* Gross Power

DUMPER

507- 406









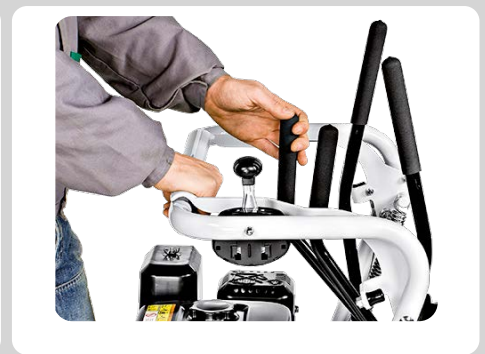











DUMPER 406



DUMPER 507













									
Dumper 406	G 200 FA Loncin	HP 5.5 - kW 4.1	196/1			I 1,0 km/h (0.6 mph) II 2,0 km/h (1.2 mph) III 3,5 km/h (2.2 mph)	I 1,0 km/h (0.6 mph) II 2,0 km/h (1.2 mph) III 3,5 km/h (2.2 mph)	400 kg (882 lb)	270 (595)
	GX 200 Honda	HP 5.5 - kW 4.1	196/1			I 1,0 km/h (0.6 mph) II 2,0 km/h (1.2 mph) III 3,5 km/h (2.2 mph)	I 1,0 km/h (0.6 mph) II 2,0 km/h (1.2 mph) III 3,5 km/h (2.2 mph)		268 (591))
Dumper 507	GX 270 Honda	HP 8.4 - kW 6.3	270/1			I 1,0 km/h (0.6 mph) II 2,0 km/h (1.2 mph) III 3,5 km/h (2.2 mph)	I 1,0 km/h (0.6 mph) II 2,0 km/h (1.2 mph) III 3,5 km/h (2.2 mph)	500 kg (1102 lb)	302 (666)
	R 300 D Rato	HP 8.2 - kW 6	301/1			I 1,0 km/h (0.6 mph) II 2,0 km/h (1.2 mph) III 3,5 km/h (2.2 mph)	I 1,0 km/h (0.6 mph) II 2,0 km/h (1.2 mph) III 3,5 km/h (2.2 mph)		319 (703)
	KD15 350 Kohler	HP 7.5 - kW 5.5	349/1			IV 8,7 km/h (5.4 mph)	III 3,5 km/h (2.2 mph)		312 (688)
									337 (743)

HWT 570











MULTIFORCE



										
	575 EX B&S	HP-kW	CC/1	L (US qts)						kg (lb)
HWT 570 Multiforce		HP3 - kW 2.2	140/1	0,8 (0.84)		--	41 cm (16.2 in)	15-30-50-60 mm (0.6-1.2-2-2.4 in)	60 cm (24 in)	46 (101.4)











HWT 600 WD



										
		HP-kW	CC	L (US qts)					kg (lb)	
HWT 600 WD	GCV 170 Honda	HP4.8 - kW3.6	166/1	0,9 (1)		2,5 km/h (1.5 mph)	41 cm (16.2 in)	15-30-50-60 mm (0.6-1.2-2-2.4 in)	60 cm (24 in)	47 (104)









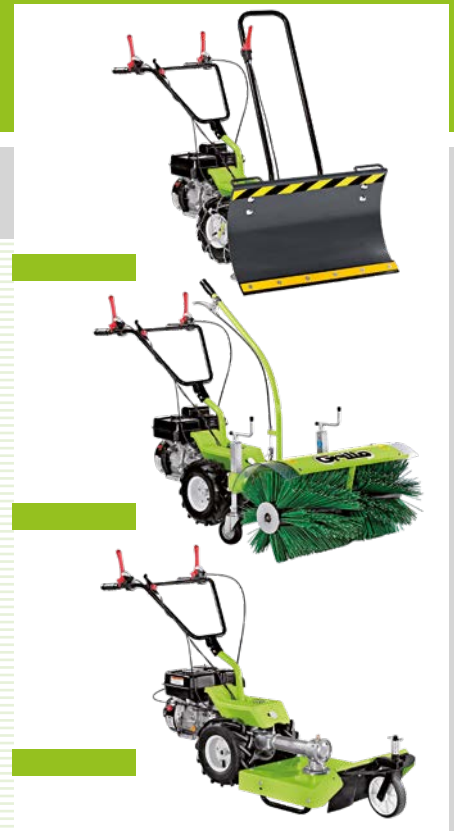

HWT 700 SUPERTRAC



										
HWT 700 SUPERTRAC	F1180V KAI Kawasaki	HP 4.5 - kW 3.4	179/1	1,7 (1.5)		2,5 km/h (1.5 mph)	3.50-8 38 cm (14.9 in)	15-30-50-60 mm (0.6-1.2-2-2.4 in)	60 cm (24 in)	62 (137)

GF 1



										
GF 1	G 200 FA Loncin	HP 5.5 - kW 4.1	196/1	3 (3.2) L (US qts)		13x5.00-6	2,20 km/h (1.4 mph)	-	86-96cm (34-38 in)	70 (154) kg (lb)

GF 2



























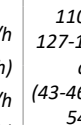













		HP-kW		 L (US qts)						 kg (lb)
GF 2	G 200 FA Loncin	HP 5.5 - kW 4.1	196/1				 4.00-8	 4.00-8	110-117 cm (43-46 in)	98 (216)
	GX 200 Honda	HP 5.5 - kW 4.1	196/1				 1,0 km/h (0.6 mph)  2,0 km/h (1.2 mph)  3,0 km/h (1.9 mph)	 1,0 km/h (0.6 mph)  2,0 km/h (1.2 mph)  3,0 km/h (1.9 mph)		96 (212)

GF 3 - GF 3DF



GF 3DF



		HP-kW	CC 	 L (US qts)		 Steering Brakes	 DIFF. LOCK				 kg (lb)
GF 3	G 300 FA Loncin	HP 9.3 - kW 6.8	302/1	 6,1 (6.4)		-	-	 4.00-8	 4.00-8	 110-117 127-132-137 cm (43-46-50-52- 54 in)	105 (231)
	GX 270 Honda	HP 8.4 - kW 6.3	270/1	 5.3 (5.6)		-	-	 1,0 km/h (0.6 mph)	 1,0 km/h (0.6 mph)		103 (227)
	KD15 350 Kohler	HP 7.5 - kW 5.5	349/1	 4,3 (4.5)		-	-	 I 1,0 km/h (0.6 mph)	 I 1,0 km/h (0.6 mph)		115 (254)
GF 3DF	G 300 FA Loncin	HP 9.3 - kW 6.8	302/1	 6,1 (6.4)				 II 2,0 km/h (1.2 mph)	 II 2,0 km/h (1.2 mph)		112 (245)
	GX 270 Honda	HP 8.4 - kW 6.3	270/1	 5.3 (5.6)				 III 3,0 km/h (1.9 mph)	 III 3,0 km/h (1.9 mph)		110 (243)
	KD15 350 Kohler	HP 7.5 - kW 5.5	349/1	 4,3 (4.5)			-	-	-		-

GH 8 - GH 9



GH 8



GH 9















GH 9



GH 9



GH 8

												
GH 8	G 200 FA Loncin	HP 5.5 - kW 4.1	196/1	3 (3.2)		HYDROSTATIC		0 - 6 km/h (0 - 3.7 mph)	0 - 3 km/h (0 - 1.9 mph)	20...60 mm (0.78...2.36 in)	58 cm (22.8 in)	135 (297)
GH 9	GX 270 Honda	HP 8.4 - kW 6.3	270/1	5,3 (5.6)		HYDROSTATIC		0 - 6 km/h (0 - 3.7 mph)	0 - 3 km/h (0 - 1.9 mph)	30...110 mm (1.2...4.3 in)	68 cm (26.8 in)	158 (348)
						85 cm (33.5 in)	165 (364)					









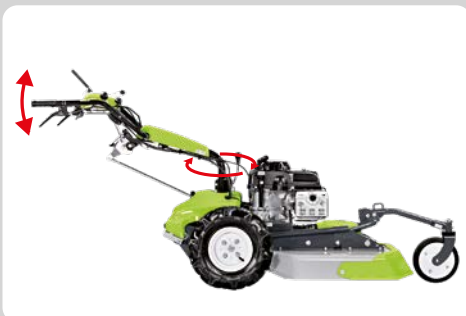

CL 62M



		HP-kW								
CL 62M	FJ180V Kawasaki	HP 4.5 - kW 3.4	179/1	 1,6 (1.5)		HYDROSTATIC		50...110 mm (2.0...4.3 in)	62 cm (24.4 in)	98 (216)
						0 - 4,7 km/h (0 - 2.9 mph)	0 - 3 km/h (0 - 1.9 mph)			

CL 75



		HP-kW		 L (US qts)		 DIFF. LOCK					 kg (lb)		
CL 75	GXV 390 Honda	HP 10.2 - kW 7.6	389/1	2,1 (2.2)		✓	HYDROSTATIC		0 - 6 km/h (0 - 3.7 mph)	0 - 3,5 km/h (0 - 2.2 mph)	50...150 mm (2.0...5.9 in)	75 cm (29.5 in)	140 (309)

CLIMBER 7

7.15 - 7.18



CLIMBER 7.18















CLIMBER 7.18



CLIMBER 7.15



		HP-kW		 L (US qts)	 DIFF. LOCK	 HYDROSTATIC				 kg (lb)
7.15	LC1P92F Loncin	HP 12 (*15) kW 9.2	452/1	 7 (7.4)		0 - 9 km/h (0 - 5.6 mph)	45 cm (18 in)	35...85 mm (1.3...3.3 in)	85 cm (33.5 in)	250 (551)
7.18	7180 EXi INTEK B&S	HP 15.2 (*18) kW 11.2	656/2	 7 (7.4)		0 - 9 km/h (0 - 5.6 mph)	45 cm (18 in)	35...85 mm (1.3...3.3 in)	85 cm (33.5 in)	255 (562)









CLIMBER 8

8.22



KIT MULCHING



		HP-kW		 L (US qts)						
8.22	7220 PXi PROFESSIONAL B&S	HP 18 (*22) kW 13.2	656/2	7 (7.4)	✓	HYDROSTATIC 0 - 10 km/h (0 - 6.2 mph)	60 cm (23.6 in)	35...110 mm (1.3...4.3 in)	91 cm (36 in)	290 (639)

* Gross Power

CLIMBER 9

9.18 - 9.22



CLIMBER 9.18











CLIMBER 9.22



CLIMBER 9.18











KIT MULCHING

		HP-kW		 L (US qts)	 DIFF. LOCK	 HYDROSTATIC				 kg (lb)
9.18	7180 EXi INTEK B&S	HP15.2 (*18) kW11.2	656/2	13 (13.7)	✓	HYDROSTATIC 0 - 10 km/h (0 - 6.2 mph)	38 cm (15 in)	30...90 mm (1.2...3.5 in)	91 cm (36 in)	297 (655)
9.22	7220 PXi PROFESSIONAL B&S	HP18 (*22) kW13.2	656/2	13 (13.7)	✓	HYDROSTATIC 0 - 10 km/h (0 - 6.2 mph)	38 cm (15 in)	30...90 mm (1.2...3.5 in)	91 cm (36 in)	311 (686)

CLIMBER 9

9.27













										
	HP-kW	CC	L (US qts)	DIFF. LOCK	HYDROSTATIC				kg (lb)	
9.27	8290 CXi COMMERCIAL B&S	HP22 (*27) KW 16.2	724/2	13 (13.7)	✓	0 - 11,5 km/h (0 - 7.1 mph)	70 cm (27.5 in)	35...135 mm (1.4...5.3 in)	98 cm (38 in)	358 (789)

* Gross Power

CLIMBER 10

2WD 27



		HP-kW		 L (US qts)	 DIFF. LOCK	 HYDROSTATIC				 kg (lb)
2WD 27	FS 730V KAWASAKI	HP22 (*27) kW16.2	726/2	 13 (13.7)		0-9,5 km/h (0 - 5.9 mph)	65 cm (25.6 in)	35...135 mm (1.4...5.3 in)	98 cm (38,5 in)	375 (827)

CLIMBER 10

AWD 27- AWD 22



CLIMBER 10 AWD 22



CLIMBER 10 AWD 27











AWD 27



AWD 22













		HP-kW		 L (US qts)	 DIFF. LOCK	 HYDROSTATIC				 kg (lb)
AWD 22	7220 PXi PROFESSIONAL B&S	HP 18 (*22) kW 13.2	656/2	13 (13.7)	✓	0 - 9 km/h (0 - 5.6 mph)	70 cm (27.5 in)	35...135 mm (1.4...5.3 in)	93 cm (36.6 in)	345 (761)
AWD 27	8290 CXi COMMERCIAL B&S	HP 22 (*27) kW 16.2	724/2	13 (13.7)	✓	0 - 9 km/h (0 - 5.6 mph)	70 cm (27.5 in)	35...135 mm (1.4...5.3 in)	98 cm (38.6 in)	385 (849)

* Gross Power

FK 700



										
FK 700	D 722 E4B Kubota STAGE 5	HP 18 kW/13.2	722/3	Diesel 31 (8.1)	✓	0 - 15 km/h (fast) 0 - 8 km/h (slow).	37 cm (14.5 in)	0...100 mm (0...3.9 in)	115 cm (45.2 in)	615 (1356)

MD 15-MD 18



MD 18













MD 18



MD 15











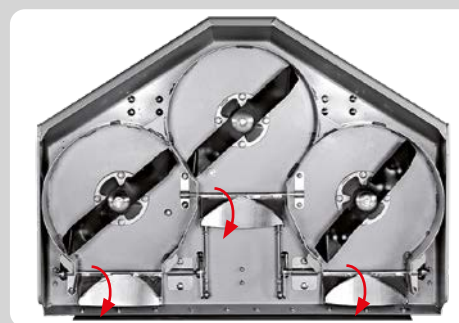

MD 18

		HP-kW		 L (US qts)						 kg (lb)
MD 15	LC1P92F Loncin	HP 12 (*15) kW 9.2	452/1	 7 (7.4)	--	HYDROSTATIC 0 - 9 km/h (0 - 5.6 mph)	45 cm (18 in)	25...75 mm (1.0...3.3 in)	QUICK SHIFT 83 cm (32.6 in)	225 (496)
MD 18	7180 EXI INTEK B&S	HP 15.2 (*18) kW 11.2	656/2	 7 (7.4)	✓	HYDROSTATIC 0 - 9 km/h (0 - 5.6 mph)	45 cm (18 in)	25...80 mm (1.0...3.5 in)	QUICK SHIFT 83 cm (32.6 in)	238 (525)

* Gross Power

MD 22N



		HP-kW		 L (US qts)	 DIFF. LOCK	 HYDROSTATIC	 48 cm (18.9 in)	 25...110 mm (0.9...4.3 in)	 QUICK SHIFT	 kg (lb)
MD 22N	7220 PXi PROFESSIONAL B&S	HP 18 (*22) kW 13.2	656/2	7 (7.4)	✓	0 - 10,5 km/h (0 - 6,5 mph)				315 (694)

MD 24 AWD

MD 28 AWD



MD 24 AWD













MD 28 AWD



MD 24 AWD













										
	7220 PXi PROFESSIONAL B&S	HP 18 (*22) KW 13.2	656/2	13 (11.8)	✓	HYDROSTATIC 0-9 km/h (0 - 5,6 mph)	70 cm (27.5 in)	25...110 mm (0.9...4.3 in)	QUICK SHIFT 106 cm (41.7 in)	370 (816)
MD 24 AWD										
MD 28 AWD	8290 CXi COMMERCIAL B&S	HP 22 (*27) KW 16.2	724/2	13 (11.8)	✓	0-9 km/h (0 - 5,6 mph)	70 cm (27.5 in)	25...110 mm (0.9...4.3 in)	125 cm (49.2 in)	389 (856)

* Gross Power

FX 27

Zero-Turn













										
	8290 CXi COMMERCIAL B&S	HP.22 (*27) kW 16.2	724/2	30 (7.9)	HYDROSTATIC	ZERO TURN	ELECTRIC	QUICK SHIFT	484 (1067)	H 170 cm D 132 cm W 258 cm
FX 27										

FD 220E













Full Electric



											
	MAX POWER	DEC POWER	TRACTION POWER	BATTERY CAPACITY						kg (lb)	H D W
FD 220E	11,7 kW	10 kW	1,7 kW	7,7 kWh	0 - 10 km/h (0 - 6.2 mph)	200 L 5.7 (US bu)	30 cm (11.8 in)	25...90 mm (1.0...3.5 in)	80 cm (31 in)	316 (696.6)	H 114 cm D 86 cm W 234 cm















FD 220R



		HP-kW		 L (US qts)						 kg (lb)	
FD 220R	LC1P92F Loncin	HP 12 (*15) kW 9.2	452/1	 7 (7.4)	HYDROSTATIC 0 - 9 km/h (0 - 5.6 mph)	200 L 5.7 (US bu)	30 cm (11.8 in)	30...90 mm (1.2...3.5 in)	80 cm (31 in)	263 (580)	H 114 cm D 86 cm W 234 cm
	VANGUARD 16 B&S	HP 14 (*16) kW 10.3	479/2	 7 (7.4)	HYDROSTATIC 0 - 9 km/h (0 - 5.6 mph)	200 L 5.7 (US bu)	30 cm (11.8 in)	30...90 mm (1.2...3.5 in)	80 cm (31 in)	270 (595)	

FD 280



		HP-kW		 L (US qts)								
FD 280	VANGUARD 16 B&S	HP 14 (*16) kW10.3	479/2	 8 (8.4)		HYDROSTATIC 0-9,5 km/h (0-5.9 mph)	ELECTRIC 280 L 8 (US bu)	 30 cm (11.8 in)	 30...90 mm (1.2...3.5 in)	113 cm (44 in)	320 (705)	H 120 cm D 119 cm W 238 cm

* Gross Power

FD 450



		HP-kW	CC	L (US Gal)	DIFF. LOCK	HYDROSTATIC	HYDRAULIC	HYDRAULIC	ELECTRIC		kg (lb)	H ¹ 194 cm H 146 cm D 119 cm W 268 cm
FD 450	7220 PXi PROFESSIONAL B&S	HP 18 (*22) kW 13.2	656/2	17 (4.5)	✓	0 - 11 km/h (0 - 6.8 mph)	450 L 12.8 (US bu)	30 cm (11.8 in)	25...90 mm (1.0...3.5 in)	113 cm (44 in)	450 (992)	

FD 500









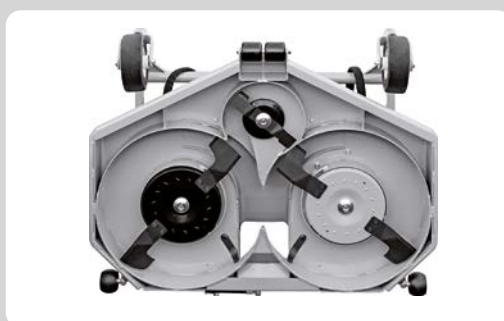





		HP-kW		 L (US Gal)	 DIFF. LOCK					 kg (lb)	
FD 500	D 722 E4B Kubota STAGE 5	HP 18 - kW 13.2	722/3	Diesel 22 (5.8)	✓	0 - 13 km/h (0 - 8 mph)	700 L 19.8 (US bu)	32 cm (12.5 in)	ELECTRIC 25....90 mm (0.9...3.5 in)	113 cm (44.4 in)	610 (1345)
											H ¹ 193 cm H 151 cm D 119 cm W 271 cm

FD 900

4WD













												
		HP-kW	CC	L (US Gal)	DIFF. LOCK	HYDROSTATIC	HYDRAULIC	HYDRAULIC	HYDRAULIC		kg (lb)	H ¹ H ² D W
FD 900 4WD	3TNV80F Yanmar STAGE 5	HP 25 - kW 18.4	1267/3	Diesel 31 (8.2)	✓	0 - 15 km/h (0 - 9 mph)	750 L 21.3 (US bu)	37 cm (14.6 in)	20...100 mm (0.8...3.9 in)	126 cm (49.6 in)	980 (2160)	H ¹ 207 cm H ² 166 cm D 133 cm W 291 cm

FD 13.09

4WD













		HP-kW	CC	 L (US Gal)	 DIFF. LOCK	 HYDROSTATIC	 HYDRAULIC	 HYDRAULIC	 HYDRAULIC	 HYDRAULIC	 kg (lb)	 H ¹ 213 cm H 175 cm D 141 cm W 325 cm
FD 13.09 4WD	3TNV82A Yanmar STAGE 5	HP 26 - kW 18.9	1331/3	Diesel 23 (6.0)	✓	0 - 15 km/h (0 - 9.3 mph)	900 L 25.5 (US bu)	31 cm (12 in)	20...100 mm (0.8...3.9 in)	132 cm (52 in)	1230 (2712)	H ¹ 213 cm H 175 cm D 141 cm W 325 cm
									20...120 mm (0.8...4.7 in)	152 cm (59.8 in)	1310 (2888)	H ¹ 213 cm H 175 cm D 162 cm W 340 cm

FD 2200

4WD



		HP-kW		 L (US Gal)	 DIFF. LOCK	 HYDROSTATIC	 HYDRAULIC	 HYDRAULIC			 kg (lb)	
FD 2200 4WD	3TNV88C Yanmar STAGE 5	HP 37 kW 27.5	1642/3	Diesel 50 (13.2)	✓	0 - 20 km/h (0 - 12.4 mph)	1200 L 34 (US bu)	62 cm (24 in)	25...110 mm (0.9...4.3 in)	152 cm (59.8 in)	1490 (3285)	H ⁺ 243cm H 183 cm D 162 cm W 347 cm

FD 2200 TS

4WD













		HP-kW		 L (US Gal)	 DIFF. LOCK	 HYDROSTATIC	 HYDRAULIC	 HYDRAULIC	 HYDRAULIC	 HYDRAULIC	 kg (lb)	
FD 2200 TOP SCORER 4WD	4TNV88C Yanmar STAGE 5	HP 47 kW 34.3	2190/4	Diesel 50 (13.2)	✓	0 - 21 km/h (0 - 13.6 mph)	1400 L 39.7 (US bu)	60 cm (24 in)	20...120 mm (0.8...4.7 in)	152 cm (59.8 in)	1656 (3651)	H ¹ 231 cm H 199 cm D 162 cm W 364 cm
										182 cm (71.6 in)	1705 (3758)	H ¹ 231 cm H 199 cm D 194 cm W 369 cm

FM 13.09

4WD













		HP-kW		 L (US Gal)	 DIFF. LOCK	 HYDROSTATIC		 HYDRAULIC		 LMP	 kg (lb)	
FM 13.09 4WD	3TNV82A Yanmar STAGE 5	HP26-kW18.9	1331/3	Diesel 23 (6.0)	✓	0 - 15 km/h (0 - 9.3 mph)	12000 m ² /h	31 cm (12 in)	20...100 mm (0.8...3.9 in)	160 cm (63 in)	1150 (2535)	H ⁺ 213 cm H 175 cm D 192 cm W 299 cm

FM 2200

4WD



		HP-kW		 L (US Gal)	 DIFF. LOCK			 HYDRAULIC			 kg (lb)	
FM 2200 4WD	3TNV88C Yanmar STAGE 5	HP 37 kW 27.5	1642/3	Diesel 50 (13.2)	✓	HYDROSTATIC 0 - 20 km/h (0 - 12.4 mph)	15500 m ² /h	HYDRAULIC 62 cm (24 in)	20...90 mm (0.8...3.5 in)	LMP 160 cm (63 in)	1322 (2915)	H ⁺ 243 cm H 183 cm D 192 cm W 347 cm



Nell'ottica di un costante sviluppo dei propri prodotti, Grillo Spa si riserva il diritto di cambiare le specifiche tecniche e le illustrazioni su questo documento in qualsiasi momento e senza preavviso né obbligo. Foto e caratteristiche non contrattuali. In his pursuit of constant development of his products, Grillo Spa reserves the right to change the technical specifications and the illustrations on this document, at any given moment and without any kind of obligation. All the pictures characteristics are not contract-binding. En poursuivant une politique constante d'amélioration de ses produits, Grillo Spa se réserve le droit de modifier les spécifications techniques en tout temps sans préavis ni obligation. Photographies et caractéristiques non contractuelles. Aufgrund ständiger Weiterentwicklung behält sich Grillo Spa Änderungen in Form, Technik und Ausstattung der Produktpalette vor. Aus Angaben und Abbildungen des vorliegenden Grillo-Katalogs können daher keine Ansprüche abgeleitet werden. Aus vista de un desarrollo constante de sus productos, Grillo Spa se reserva el derecho de cambiar las especificaciones técnicas y las ilustraciones mostradas en este documento en cualquier momento y sin aviso previo. Las fotos y características no son contractuales.



www.grillospa.it
 e-mail: grillo@grillospa.it
 Tel. (0039) 0547.633111
 Fax (0039) 0547.632011

www.grillofrance.fr
www.grillodeutschland.de
www.grilloagrigarden.co.uk
www.grilloaustralia.com.au
www.grilloagrigarden.ru